



Video Over IP Controller

Manual

English



No. 38263 (Fw ver. 2.18)

lindy.com

LINDY

Introduction	1
Package contents	1
Features	1
Specifications	1
Overview	2
<i>FRONT PANEL</i>	2
<i>REAR PANEL</i>	2
<i>IR EXTENDER</i>	3
<i>IR REMOTE CONTROL</i>	3
Installation	3
Operation	3
<i>DISCOVERY TOOL</i>	3
<i>WebGUI CONTROL PAGE</i>	4
<i>TELNET CONTROL</i>	13
<i>RS232 INTERFACES DESCRIPTION</i>	17

Introduction

Thank you for purchasing the Video Over IP Controller. This product has been designed to provide trouble free, reliable operation. It benefits from both a LINDY 2 year warranty and free lifetime technical support. To ensure correct use, please read this manual carefully and retain it for future reference.

This Video Over IP Controller enables the management and configuration of multiple Video over IP (VoIP) extenders (No.38266 and 38267) through a single WebGUI, that provides the complete status of all connected transmitters (No.38266) and receivers (No.38267), including IP address, channel selection and video preview. It also features local console ports including an HDMI output and one USB port for the connection of a keyboard or mouse (or both via a USB hub), to view and interact with the WebGUI.

Package Contents

- Video Over IP Controller
- Multi-country 5V DC 2.6A PSU, 5.5mm / 2.1mm with EU, UK, US and AUS adapters
- 1 x terminal block (3-pin)
- 3 x terminal block (5-pin)
- 3.5mm to IR extender cable
- Remote control (with included CR2025 battery)
- 4 x rubber feet
- OSS statement
- Lindy QIG (Quick Installation Guide)

Features

- Enables the management and configuration of multiple Video over IP (VoIP) extender (No.38266 and 38267) through a single WebGUI
- Supports point-to-point (unicast) and multipoint-to-multipoint (multicast) routing selections
- Controls both Matrix and TV wall configurations using WebGUI presets
- Definable display groups to simplify large installations
- WebGUI provides the complete status of all connected transmitters (No.38266) and receivers (No.38267), including IP address, channel selection and video preview.
- Local console featuring an HDMI output and one USB port for the connection of a keyboard or mouse (or both via a USB hub), to view and interact with the WebGUI

Specifications

- Control modes: WebGUI (remote or local), RS-232, Telnet, Trigger and IR Remote
- RJ45 Gigabit Ethernet port with PoE support (802.3af)
- Output port: 1 x HDMI Female (resolution: 1920x1080@60Hz)
- Control ports: 1 x RS232 (3 pin terminal block), 8 x Trigger Contacts (10 pin terminal block), 1 x USB Type A Female, 2 x RJ45, 1 x Factory Reserved Connector (5 pin terminal block)
- IR Frequency: 30 – 50kHz
- Power Consumption: 2.99 W
- Operating Temperature: 0°C - 40°C (32°F - 104°F)
- Storage Temperature: -20°C - 60°C (-4°F - 140°F)
- Operating Humidity: 20% - 90% (non-condensing)
- Storage Humidity: 20% - 90% (non-condensing)

Overview

Front Panel



- 1. **Power LED** – Flashes during power up and stays illuminated whilst the unit is operating.
- 2. **IR Eye** – Receives the IR signal from the included IR remote control

Rear Panel

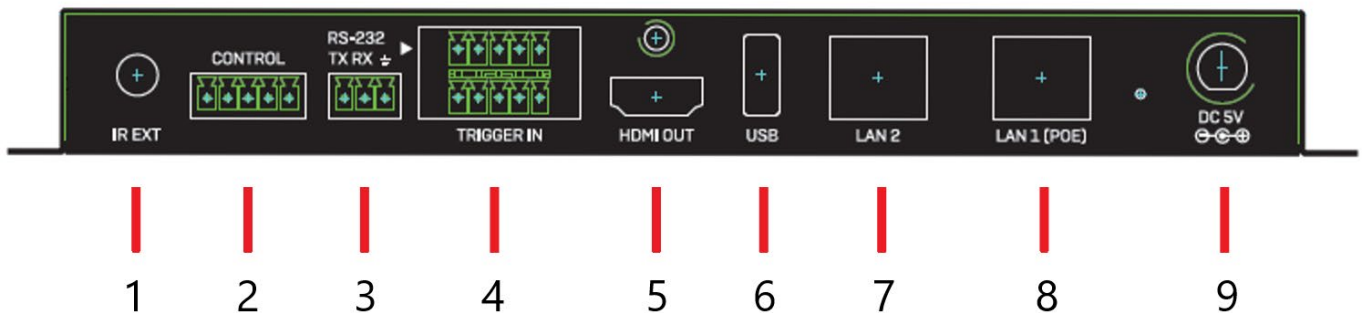

- 1. **IR Ext** - Connects to the provided IR extender to extend the IR control range of the unit.
- 2. **Control** – Socket reserved for factory updates
- 3. **RS-232** – Serial socket to be connected with a serial controller or PC through the supplied terminal
- 4. **Trigger IN**: Connects any trigger device (not supplied) such as, control keypads, security alarms, door switches, etc. Each of the 8 trigger inputs can be used to activate an associated preset. The trigger needs a minimum of 5V to be activated
- 5. **HDMI OUT port** – Connects a display with a standard HDMI cable (not included) used for direct local monitoring / management of the unit.
- 6. **USB**: Connects a USB mouse and/or keyboard to control the unit's WebGUI displayed on the HDMI output port. Firmware update via USB is also supported.
Note: Specialized USB control devices, such as a touch panel, should be connected before the unit is powered on.
- 7. **LAN 2** – Connect this port to the network used to control the unit via WebGUI / Telnet
- 8. **LAN 1 (PoE)** – This port must be connected to the network where all the controlled units (No. 38266 and 38267 – not included) are connected to. If this port is connected to an IEEE802.3af. compliant switch the unit can get power directly from it avoiding to use the included PSU.
- 9. **DC Power socket** – Attach the supplied PSU here.

IR Extender

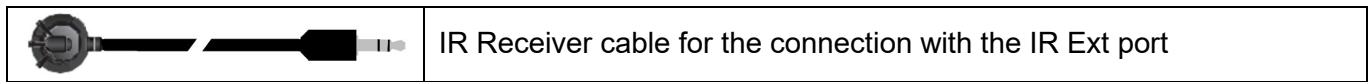

Remote Control

The included remote control has 8 buttons that recall an associated preset allowing the user to quickly change the screen layout.



Installation

Please follow the following steps to install the Video over IP Controller:

1. Please make sure that all the devices included in the installation are shut down
2. Connect, as required, the HDMI, USB (for keyboard and mouse or control devices only), Serial and Trigger ports on the unit to the devices you want to attach to this system using standard cables.
3. Connect, as required, the IR extender cable to the **IR EXT** port
4. Connect a standard RJ45 Ethernet cable to the “**LAN 2**” port and to the network where the (No. 38266 and 38267) units are connected to. If you are connecting the units to a Gigabit PoE (IEEE 802.3af compliant) switch you can skip step 6 and avoid using the supplied PSU.
5. Connect a standard RJ45 Ethernet cable to the “**LAN 1 (PoE)**” port to the network where the used control PC to is connected to.
6. Connect (if required) the supplied PSU DC plug to the DC 5V ports
7. Turn on all the connected devices.

Now all the connections are made and the system is ready to be configured and distribute the managed signals. Please refer to the full manual published on the product’s page (www.lindy.com) to proceed with a detailed configuration.

Operation

Please refer to the following section to control the device through the integrated WebGUI or with RS232 serial interface

Device Discovery Tool

Please download the “Device Discovery” software from the Lindy website (you can find in the page dedicated to this device) and save it in a directory where you can easily find it. Connect the unit and your PC/laptop to the same active network and execute the “Device Discovery” software. Click on “Find Devices on Network” and a list of devices connected to the local network will show up indicating their current IP address.

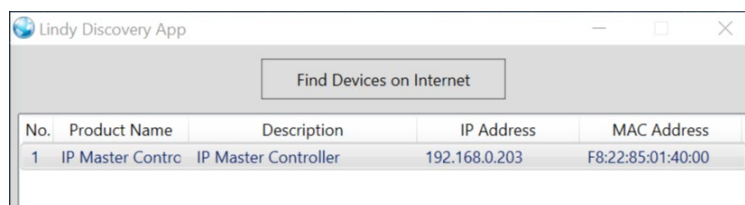

By clicking on one of the listed devices you will be presented with the network details of that particular device.

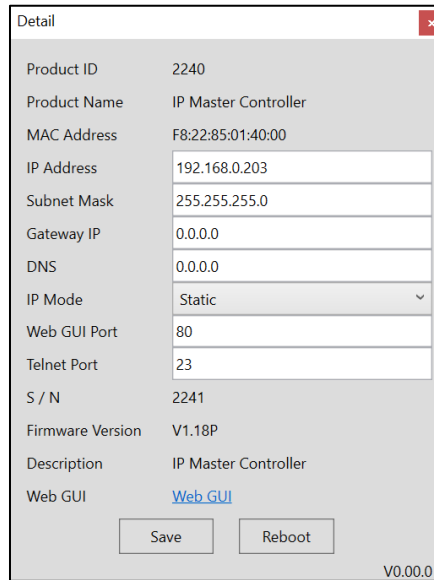

IP Mode:

If you choose, you can alter the static IP network settings for the device, or switch the unit into DHCP mode to automatically obtain proper network settings from a local DHCP server. To switch to DHCP mode, please select DHCP from the IP mode drop-down, then click “Save” followed by “Reboot”.

WebGUI Hotkey:

Once you are satisfied with the network settings, you may use them to connect via Telnet or WebGUI. The network information window provides a convenient link to launch the “WebGUI” directly.

WebGUI CONTROL PAGE

All functions of this unit are controllable via the built in WebGUI which is accessed by connecting your web browser to LAN 2’s IP address or by connecting an HDMI display to the unit’s HDMI output and attaching a USB mouse and keyboard to the unit’s USB port. This control is presented across a number of separate tabs, including Monitor & Control, Preset Recall, System, Setting, Transmitter, and Receiver.

A setup wizard is also provided to help simplify first-time setup. The individual functions will be introduced in the following sections.

When no user is logged in, a limited selection of tabs are available (Monitor & Control, Preset Recall, and System). This allows for easy user access to routing selection and presets while still protecting the more sensitive and critical setup and configuration controls. To log in to the WebGUI, switch to the System tab and click on the “Login” button.

By default, both the Username and Password are set to “admin” for the WebGUI. The administrator password can be changed within the System tab of the WebGUI if desired.

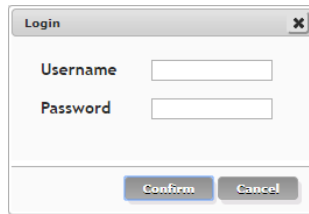

If you are unsure of the unit's current LAN 2 IP address, please check the unit's HDMI status display.

Monitor & Control Tab

This tab provides a graphical representation of all current Transmitters, Receivers and video groups. It also provides a simple way to change video routing by using drag and drop. The video thumbnails may be set to automatically update every few seconds by clicking the "Auto Refresh" switch to the right.

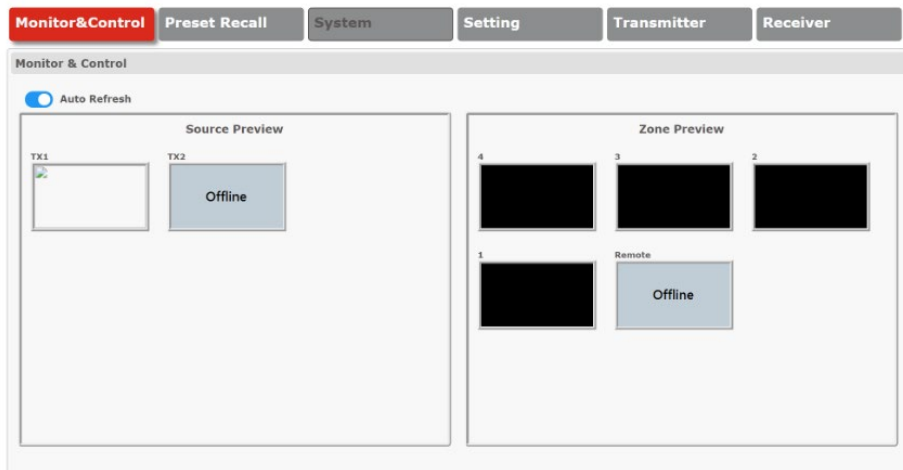

NOTE: This tab is fully functional even when the user is logged out.

- Source Preview

This window displays preview thumbnails from all detected Transmitters along with their assigned names. To route a Transmitter's source to a different Receiver, or to a video group, drag-and-drop can be used. Click and drag the thumbnail from the Source side to drop it onto the preferred Receiver or Display Group on the Zone side.

- Zone Preview

This window displays preview thumbnails from all detected Receivers along with their assigned names. All available Display Groups are also displayed here, however no preview thumbnail will be displayed for them. Display Groups are defined within the Setting tab.

Due to the potential for the displays within a video group to be showing different sources, video groups will not show a thumbnail image.

Preset Recall Tab

This tab lists all currently defined Presets and provides a simple way to activate them. To activate a saved Preset, simply click on the appropriately named button. Presets are defined within the Setting tab.

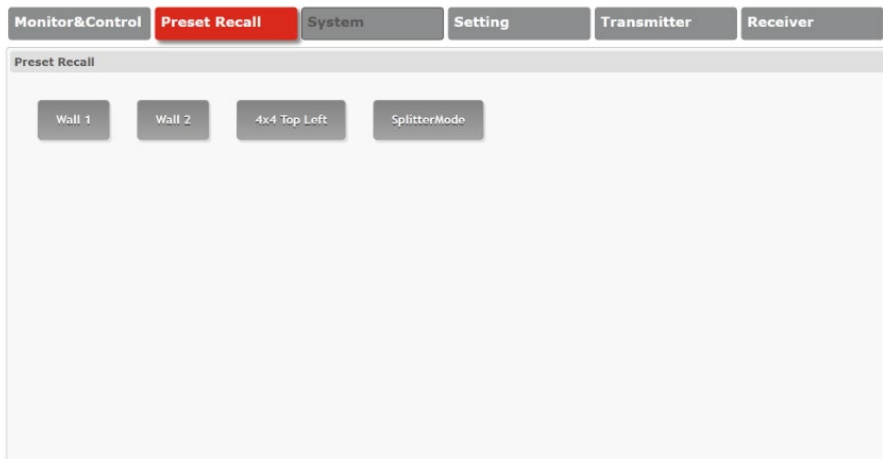

This tab is fully functional even when the user is logged out.

System Tab

This tab provides access to system configuration options including IP configuration for both LAN ports, login and user management, access to the setup wizard, and firmware update functionality.

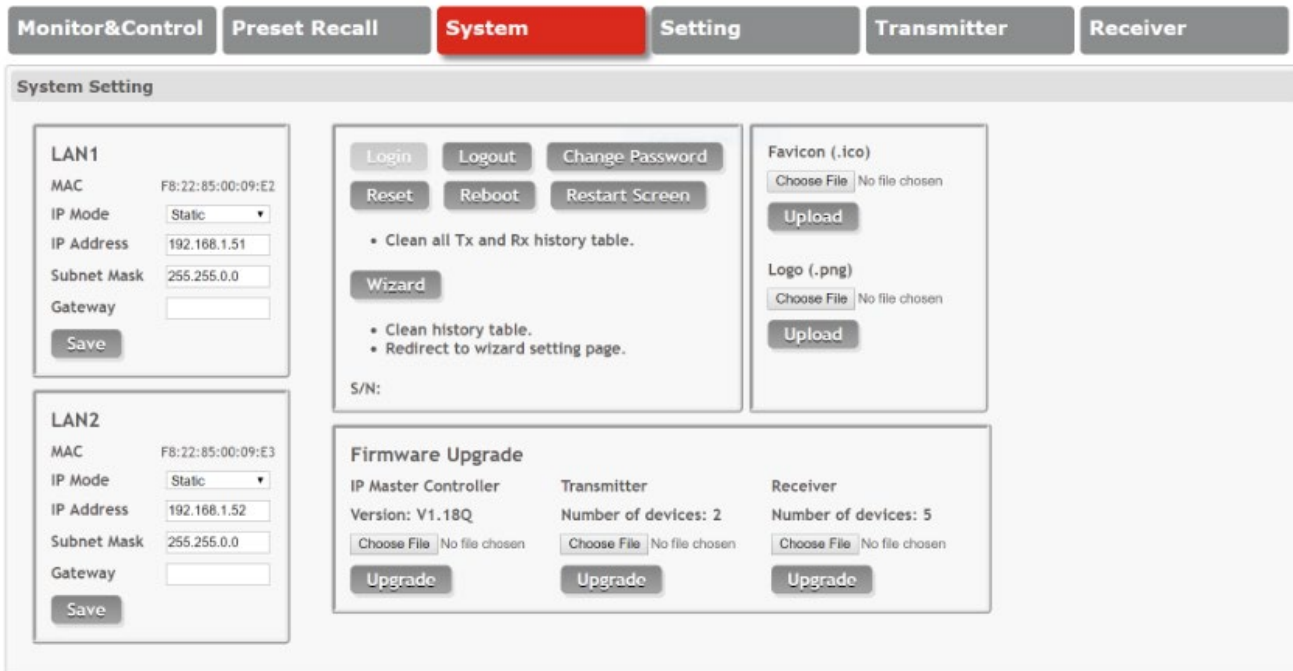

This tab will only display system information and provide a Login button if the user is logged out. All other functions will be greyed out.

- LAN1 & LAN2

The IP mode for each LAN port (DHCP, Static IP, or Auto IP), IP address, netmask, and gateway can be set here. When a LAN port is set to Auto IP mode it will automatically assign itself an APIPA address from

the 169.254.XXX.XXX range. When a LAN port is set to "DHCP" mode, it will automatically attempt to obtain proper configuration information from the local DHCP server. If no DHCP server is available, or the user wishes to configure the network settings manually, please set the LAN port to "Static IP" mode and enter the information as appropriate for the connected network. Press "Save" to activate the changes.

LAN1 defaults to "Auto IP" mode and is intended to be connected to the VoIP device network. LAN2 defaults to "DHCP" mode and is intended to be connected to a normal local network for easy access to the WebGUI.

- Login & Logout

Click these buttons to log in or log out of the WebGUI interface. When logged out, available WebGUI functionality is limited.

- Change Password

Click this button to change the WebGUI's administrator login password.

- Reset

Click this button to clear all detected transmitter/receiver information, all groups and all presets. LAN settings will not be reset.

- Reboot

Click this button to reboot the unit.

- Wizard

Click this button to launch the setup wizard. Activating the wizard will clear all detected transmitter/receiver information, all groups and all presets.

- Favicon

This allows for the upload of an icon image to use as the WebGUI's page/tab icon which is also commonly used by browsers when a web page has been bookmarked or added to favorites. The image file must be 16×16 pixels and saved in the *.ico format. The file must be named "favicon.ico".

Click the "Choose File" button, select the file from your PC's file browser, then click the "Upload" button. Once the upload is complete, refresh the WebGUI to view the new icon.

- Logo

This allows for the upload of a small logo image that will be displayed in the upper left corner of the WebGUI. The image is recommended to be no taller than 90 pixels and must be saved in the *.png format. The file must be named "logo.png".

Click the "Choose File" button, select the file from your PC's file browser, then click the "Upload" button. Once the upload is complete, refresh the WebGUI to view the corner logo.

- Firmware Upgrade

It is possible to update the firmware of this unit as well as to update the firmware of detected Transmitters (No.38266) and Receivers (No.38267). The number of currently detected Transmitters and Receivers is also listed here.

To update the unit's firmware, or the firmware of detected Transmitters or Receivers, click the "Choose File" button beneath the appropriate device type (IP Master Controller, Transmitter, or Receiver) to open the file selection window and then select an appropriate firmware update file (*.bin format) located on your local PC. After selecting the file, click the "Upgrade" button beneath the appropriate device type to begin the firmware update process. Once the firmware update process has completed each updated unit will reboot. The firmware update process can take several minutes, please do not power the units off once the process has begun.

Setup Wizard

Pressing the "Wizard" button will start the step by step Setup Wizard.

It will also clear the unit's stored Transmitter/Receiver history, Presets, and Groups. The following 4 windows will then be presented, in order, to simplify the initial setup of a new Video over IP routing installation. Prior to pressing the "Finish" button on the final page of the wizard, it is possible to move freely between all 4 steps of the Setup Wizard to make additional changes to the configuration. Once "Finish" has been pressed, the changes will be committed to all involved units and they will reboot.

(1) Transmitter Setting

This wizard step provides a way to control the detailed settings

of each detected Transmitter. First, click on the "Scan" button to check the LAN 1 network for all available Transmitters. Once the list is populated with Transmitters, the settings for each can be modified (See the "Transmitter Tab" section for configuration details). After all desired changes have been completed, press the "Next" button to move to the next wizard step.

(2) Receiver Setting

This wizard step provides a way to control the detailed settings of each detected Receiver. First, click on the "Scan" button to check the LAN 1 network for all available Receivers. Once the list is populated with Receivers, the settings for each can be modified (See the "Receiver Tab" section for configuration details).

After all desired changes have been completed, press the "Next" button to move to the next wizard step.

(3) Group Setting

This wizard step provides a way to define groups of displays that will all receive the same routed source when used in Presets or from the Monitor & Control tab (See the "Display Group Configuration" section for configuration details). After all desired Display Groups have been defined, press the "Next" button to move to the next wizard step.

(4) Preset Setting

This wizard step provides a way to add, edit or remove routing Presets (See the "Preset Configuration" section for configuration details).

After all desired Presets have been defined, press the “Finish” button to complete the Setup Wizard and commit all setup changes. All involved units will reboot.

Setting Tab

This tab allows for the assignment and configuration of routing Presets and Display Groups. Pressing the “Add” button in either section will open a new blank settings window for that section. Pressing the “Edit” button next to an existing Preset or Group item will open that settings window. Pressing the “Remove” button next to an existing Preset or Group item will delete it.

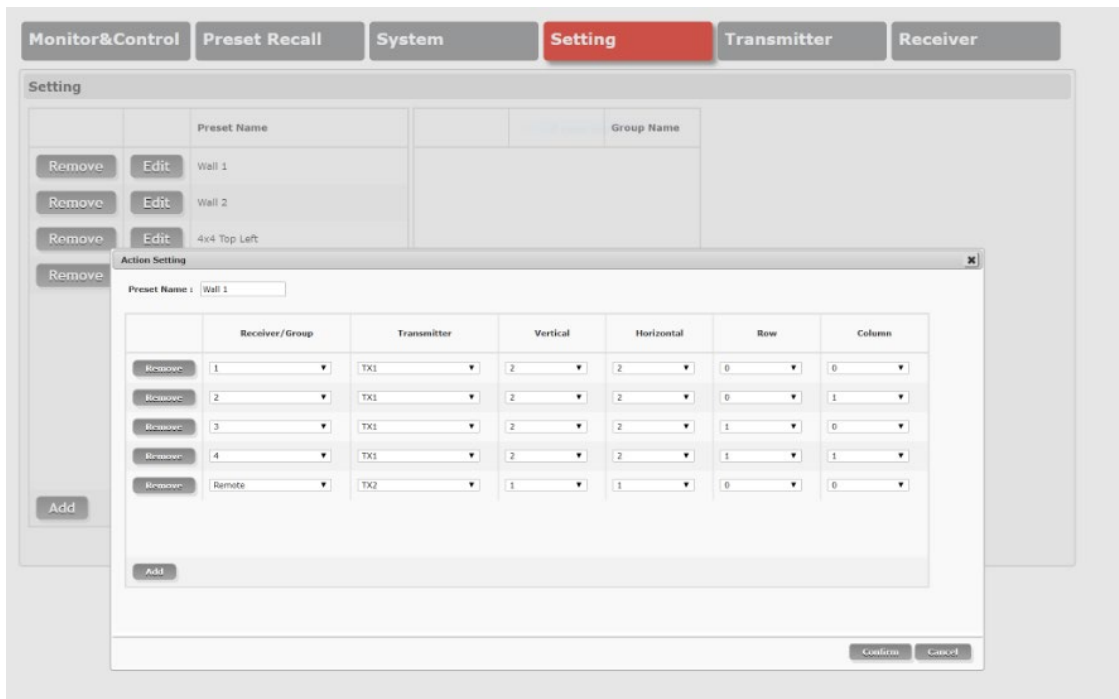

This tab is not available when the user is logged out.

- Preset Configuration

The Preset settings window provides a way to add, edit or remove routing Presets. Up to 250 Presets can be easily defined and managed.

Once the Preset settings window is open, the name of the Preset can be set at the top of the window. Pressing the “Add” button will add an additional Receiver/Group routing line. To delete an existing route, click on the “Remove” button next to the route to remove. Once all routes for the Preset have been defined, press the “Confirm” button to save the changes. Each route line has the following configurable settings:

- Receiver/Group: Use the dropdown to select a Receiver or Group to route the selected source to.
- Transmitter: Use the dropdown to select the Transmitter to route to the selected Receiver/Group.
- Vertical (Video Wall): Use the dropdown to define the number of displays in the video wall, measured vertically. (Maximum is 8 displays.)

If this route is not part of a video wall, leave the value at 1.

- Horizontal (Video Wall): Use the dropdown to define the number of displays in the video wall, measured horizontally. (Maximum is 8 displays.) If this route is not part of a video wall, leave the value at 1.
- Row (Video Wall): Set the vertical position of the currently selected display. (Counts top to bottom, from 0 to 7.) If this route is not part of a video wall, leave the value at 0.
- Column (Video Wall): Set the horizontal position of the currently selected display. (Counts top to bottom, from 0 to 7.)

If this route is not part of a video wall, leave the value at 0.

Please note: if you require to set up a Video Wall larger than 8 x 8 please refer to the Telnet control section. The WebGUI interface is limited to 8 x 8 because of the video preview feature.

- Display Group Configuration

The Display Group device selection window provides a way to define a group of displays that will all receive the same routed source when used in Presets or from the Monitor & Control tab. The name of the Display Group is set at the top of the window. To add Receivers to the Display Group, click on the name of each one to include. To remove a Receiver from the group, click on the Receiver’s name a second time. After all selections have been made, click on the “Confirm” button to save the changes.

Transmitter Tab

This tab provides a way to control the detailed settings of each detected Transmitter. After all desired changes have been completed, press the “Apply” button to send the changes to the appropriate Transmitters and activate them. After receiving the new settings, each Transmitter will reboot.

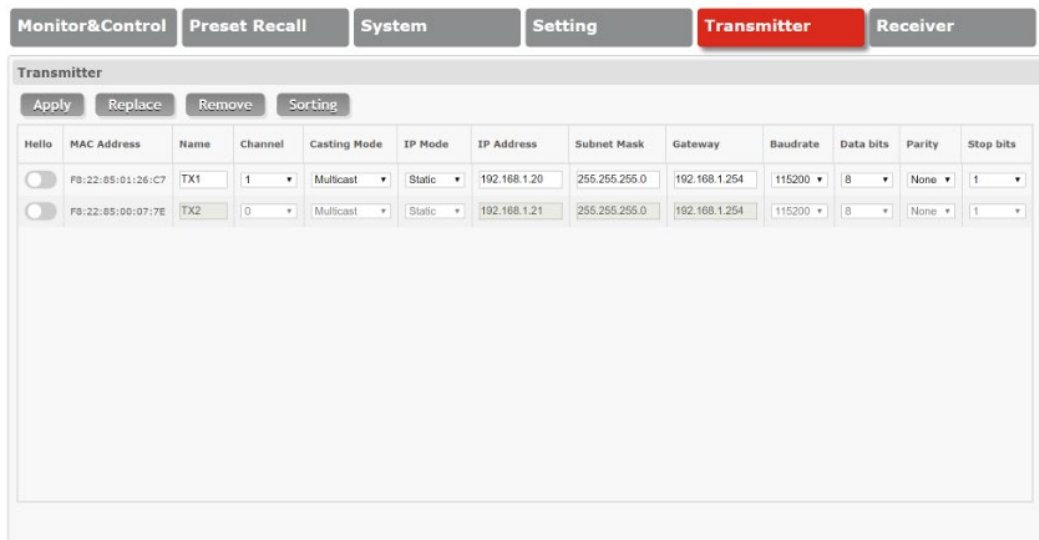

This tab is not available when the user is logged out.

- Transmitter Configuration
 - Hello: Clicking on this switch will cause the selected unit to immediately begin flashing the LEDs on the front of the unit to make it easy to find. Clicking it a second time returns the LEDs to their normal behavior.

- **MAC Address:** Displays the unit's detected MAC address. Hovering the mouse over the MAC address will display the unit's current firmware revision.
- **Name:** The unit's assigned name can be changed here. Up to 12 alpha-numeric characters are allowed. By default, new units will use their MAC address as their name.
- **Channel:** Use the dropdown to select the broadcast channel for the Transmitter. All Receivers on the local network that are set to the same channel will receive video from this Transmitter. The available channel range is from 0 to 255. Every Transmitter within the same local network must be assigned a different broadcast channel in order to avoid conflicts.
- **Casting Mode:** Use the dropdown to switch the broadcasting mode used by the unit between Multicast and Unicast.

Receivers must be set to the same casting mode as the Transmitter in order to receive video.

- **IP Mode & IP Settings:** The IP mode of each unit may be switched between "Auto IP", "DHCP" or "Static IP". When the unit is set to Auto IP mode it will automatically assign itself an APIPA address from the 169.254.XXX.XXX range. When the unit is set to DHCP mode it will attempt to automatically obtain an IP address from a DHCP server. When the IP mode is set to static IP, you can manually set the IP address, netmask and gateway address.

The default network setting is "Auto IP".

- **Serial Settings:** Set the desired baud rate, data bits, parity, and stop bits for the unit's RS-232 extension function. Linked Transmitters and Receivers must have the same serial settings.
- **Replace and Remove Transmitters**

When a Transmitter has been removed from the local network, or is otherwise no longer accessible, and needs to be replaced, or removed completely, then the Replace and Remove buttons will provide that functionality.

- **Replace:** Click on this button to replace any currently listed Transmitter with a new unit. The pop-up window provides drop-downs to select the original unit, and the unit to replace it with. Once the selection has been made, click on "Confirm" to apply the change. Once the replace process has completed, the replaced unit will be removed from the list, and the new unit will have settings copied from the replaced unit.



- **Remove:** Click on this button to remove any Transmitter from the list of detected devices. The pop-up window provides a drop-down to select the unit to be removed. Once the selection has been made, click on "Confirm" to apply the change.



Receiver Tab

This tab provides a way to control the detailed settings of each detected Receiver. After all desired changes have been completed, press the “Apply” button to send the changes to the appropriate Receivers and activate them. After receiving the new settings, each Receiver will reboot.

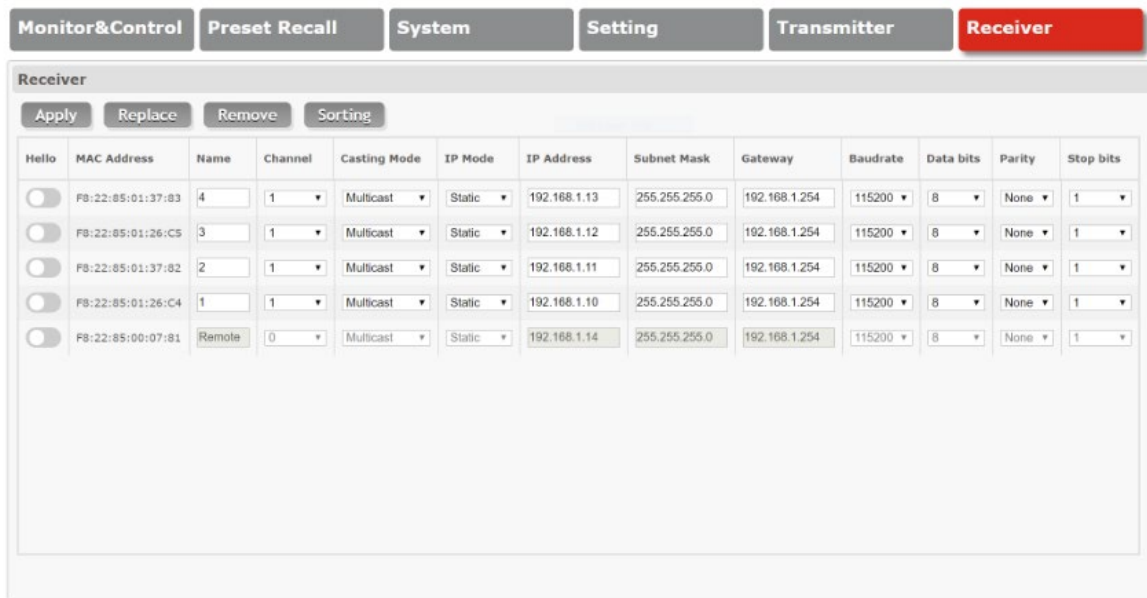

This tab is not available when the user is logged out.

- Receiver Configuration
 - Hello: Clicking on this switch will cause the selected unit to immediately begin flashing the LEDs on the front of the unit to make it easy to find. Clicking it a second time returns the LEDs to their normal behavior.
 - MAC Address: Displays the unit's detected MAC address. Hovering the mouse over the MAC address will display the unit's current firmware revision.
 - Name: The unit's assigned name can be changed here. Up to 12 alpha-numeric characters are allowed. By default, new units will use their MAC address as their name.
 - Channel: Use the dropdown to select the broadcast reception channel for the Receiver. The Receiver will display the video stream from the Transmitter using the selected broadcast channel. The available channel range is from 0 to 255.
 - Casting Mode: Use the dropdown to switch the network broadcast mode supported by the unit between Multicast and Unicast.

Receivers must be set to the same casting mode as the Transmitter in order to receive video.

- IP Mode & IP Settings: The IP mode of each unit may be switched

between "Auto IP", "DHCP" or "Static IP". When the unit is set to Auto IP mode it will automatically assign itself an APIPA address from the 169.254.XXX.XXX range. When the unit is set to DHCP mode it will attempt to automatically obtain an IP address from a DHCP server. When the IP mode is set to static IP, you can manually set the IP address, netmask and gateway address.

The default network setting is "Auto IP".

- Serial Settings: Set the desired baud rate, data bits, parity, and stop bits for the unit's RS-232 extension function.

Linked Transmitters and Receivers must have the same serial settings.

- Replace and Remove Receivers

When a Receiver has been removed from the local network, or is otherwise no longer accessible, and needs to be replaced, or

removed completely, then the Replace and Remove buttons will provide that functionality.

- Replace: Click on this button to replace any currently listed Receiver with a new unit. The pop-up window provides drop-downs to select the original unit, and the unit to replace it with. Once the selection has been made, click on "Confirm" to apply the change. Once the replace process has completed, the replaced unit will be removed from the list, and the new unit will have settings copied from the replaced unit.

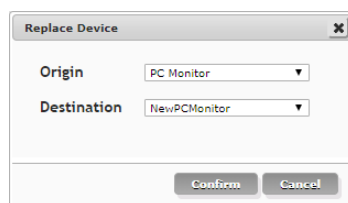

- Remove: Click on this button to remove any Receiver from the list of detected devices. The pop-up window provides a drop-down to select the unit to be removed. Once the selection has been made, click on "Confirm" to apply the change.



TELNET CONTROL

Please refer to the following Telnet command list to setup your configuration through an IP or Serial RS-232 connection. Before attempting to use Telnet control, please ensure that both the unit's LAN 2 port and the PC/laptop are connected to the same active networks.

Note 1: By default the unit will obtain the LAN 2 IP address via DHCP. If you are unsure of the unit's current LAN 2 IP address, please check the unit's HDMI status display.

Note 2: Commands will not be executed unless followed by a carriage return. Commands are not case-sensitive.

Note 3: If the unit's IP address is changed then the IP address required for Telnet access will also change accordingly.

RS-232 and Telnet Commands

COMMAND CLASS	COMMAND SINTAX	DESCRIPTION
SYSTEM COMMANDS	HELP	Show the full command list.
	GET_HARDWARE_VERSION	Show the unit's hardware version.
	GET_FIRMWARE_VERSION	Show the unit's current firmware version.
	SET_FACTORY_RESET	Reset the unit to the factory defaults.
	SET_HISTORY_RESET	Clear the unit's stored transmitter and receiver history list.
	REBOOT	Reboot the unit.
NETWORK	GET_IPCONFIG N1	Show the current Ethernet configuration of the selected port. Available values for N1: 1 [LAN Port 1] 2 [LAN Port 2]
	SET_IP_MODE N1 N2	Set the IP configuration mode. Available values for N1: 1 [LAN Port 1] 2 [LAN Port 2] Available values for N2: 0 [Static IP Mode] 1 [DHCP Mode] 2 [Auto IP Mode]
	GET_IP_MODE N1	Show the current IP configuration mode. Available values for N1: 1 [LAN Port 1] 2 [LAN Port 2]
	SET_IP_ADDRESS N1 N2	Set the static IP address for the selected LAN port Available values for N1: 1 [LAN Port 1] 2 [LAN Port 2]

		N2 = X.X.X.X [X = 0~255]
	GET_IP_ADDRESS N1	Show the current IP address of the selected LAN port Available values for N1: 1 [LAN Port 1] 2 [LAN Port 2]
	SET_NETMASK N1 N2	Set the Ethernet netmask for the selected LAN port Available values for N1: 1 [LAN Port 1] 2 [LAN Port 2] N2 = X.X.X.X [X = 0~255]
	GET_NETMASK N1	Show the current Ethernet netmask of the selected LAN port Available values for N1: 1 [LAN Port 1] 2 [LAN Port 2]
	SET_GATEWAY N1 N2	Set the IP gateway address for the selected LAN port Available values for N1: 1 [LAN Port 1] 2 [LAN Port 2] N2 = X.X.X.X [X = 0~255]
	GET_GATEWAY N1	Show the current gateway address of the selected LAN port Available values for N1: 1 [LAN Port 1] 2 [LAN Port 2]
DISCOVERY	GET_TX_DEVICE	List all supported VoIP Transmitter devices (No.38266) detected on LAN port 1's local network.
	GET_RX_DEVICE	List all supported VoIP Receiver devices (No.38267) detected on LAN port 1's local network.
PRESET / GROUP	SET_PRESET_RUN N1	Activate Preset number N1 N1 = 1 ~ 250 [Preset Number]
	GET_PRESET_RUN N1	List the contents of Preset number N1 N1 = 1 ~ 250 [Preset Number]
	SET_GROUP_ROUTE N1 N2	Set all members of Group N1 to display Channel N2 N1 = 1 ~ 255 [Group Number]

		N2 = 0 ~ 255 [Channel Number]
	GET_GROUP_MEMBER N1	List all Receivers in Group N1 N1 = 1 ~ 255 [Group Number]
INDIVIDUAL VoIP UNIT	SET_CHANNEL N1 N2	Set the Channel for the Tx or Rx at IP address N1. N1 = X.X.X.X [X = 0 ~ 255, IP of Target Unit] N2 = 0 ~ 255 [Channel Number]
	GET_CHANNEL N1	Show the current Channel used by the Tx or Rx at IP address N1. N1 = X.X.X.X [X = 0 ~ 255, IP of Target Unit]
	SET_DEVICE_NAME N1 N2	Set the name of the Tx or Rx at IP address N1. N1 = X.X.X.X [X = 0 ~ 255, IP of Target Unit] N2 = {Name} [Alpha-numeric, 12 Chars Max]
	GET_DEVICE_NAME N1	Show the current name of the Tx or Rx at IP address N1. N1 = X.X.X.X [X = 0 ~ 255, IP of Target Unit]
	SET_NET_MODE N1 N2	Set the network broadcast mode of the Tx or Rx at IP address N1. N1 = X.X.X.X [X = 0 ~ 255, IP of Target Unit] Available values for N2: 0 [Unicast Mode] 1 [Multicast Mode]
	GET_NET_MODE N1	Show the current network broadcast mode of the Tx or Rx at IP address N1. N1 = X.X.X.X [X = 0 ~ 255, IP of Target Unit]
	SET_VW_LAYOUT N1 N2 N3	Set the horizontal and vertical display count of the video wall that the Rx at IP address N1 is a part of. N1 = X.X.X.X [X = 0 ~ 255, IP of Target Unit] N2 = 1 ~ 16 [Horizontal Display Count] N3 = 1 ~ 16 [Vertical Display Count]
	GET_VW_LAYOUT N1	Show the horizontal and vertical display count of the video wall that the Rx at IP address N1 is a part of. N1 = X.X.X.X [X = 0 ~ 255, IP of Target Unit]
	SET_VW_POS N1 N2 N3	Set the horizontal and vertical position of the Rx at IP address N1 within the defined video wall.

		<p>N1 = X.X.X.X [X = 0 ~ 255, IP of Target Unit]</p> <p>N2 = 0 ~ 15 [Horizontal Position]</p> <p>N3 = 0 ~ 15 [Vertical Position]</p> <p>Note: Cannot exceed the dimensions defined by VW_LAYOUT</p>
	GET_VW_POS N1	<p>Show the horizontal and vertical position of the Rx at IP address N1 within the defined video wall.</p> <p>N1 = X.X.X.X [X = 0 ~ 255, IP of Target Unit]</p>

RS232 INTERFACE DESCRIPTION

Please refer to the following serial ports pin out and connection description to connect correctly the interface to standard RS232 devices.

Serial interface pin functions and connections

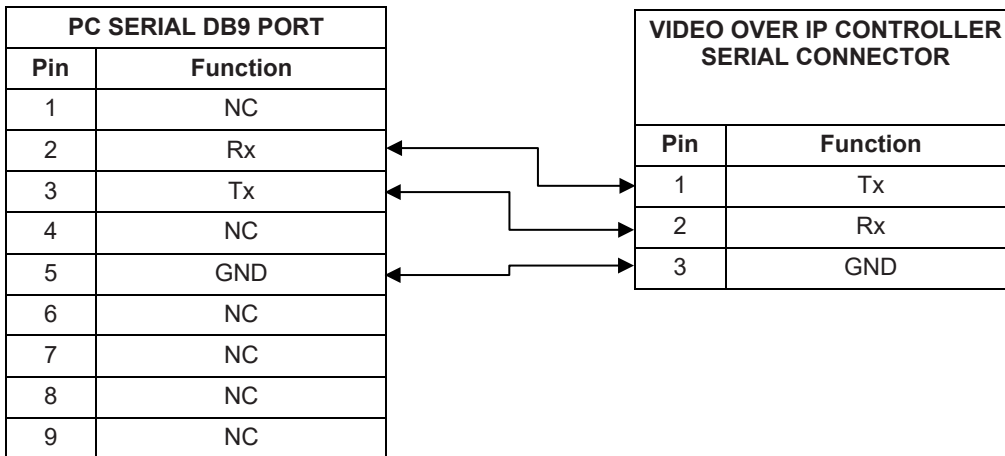

The serial interface on the PC must be set as follow:

Baud Rate: **19200**

Data Bits: **8**

Parity Bit: **None**

Stop Bits: **1**

Flow Control: **None**

CE/FCC Statement

CE Certification

LINDY declares that this equipment complies with relevant European CE requirements.

CE Konformitätserklärung

LINDY erklärt, dass dieses Equipment den europäischen CE-Anforderungen entspricht

UKCA Certification

LINDY declares that this equipment complies with relevant UKCA requirements.

FCC Certification

This equipment has been tested and found to comply with the limits for a Class B digital device, pursuant to part 15 of the FCC Rules. These limits are designed to provide reasonable protection against harmful interference in a residential installation.

You are cautioned that changes or modification not expressly approved by the party responsible for compliance could void your authority to operate the equipment.

This device complies with part 15 of the FCC Rules.

Operation is subject to the following two conditions:

1. This device may not cause harmful interference, and
2. This device must accept any interference received, including interference that may cause undesired operation.

The enclosed power supply has passed Safety test requirements, conforming to the US American versions of the international Standard IEC 60950-1 or 60065 or 62368-1.

LINDY Herstellergarantie – Hinweis für Kunden in Deutschland

LINDY gewährt für dieses Produkt über die gesetzliche Regelung in Deutschland hinaus eine zweijährige Herstellergarantie ab Kaufdatum. Die detaillierten Bedingungen dieser Garantie finden Sie auf der LINDY Website aufgelistet bei den AGBs.

Hersteller / Manufacturer (EU):

LINDY-Elektronik GmbH
Markircher Str. 20
68229 Mannheim
Germany
Email: info@lindy.com , T: +49 (0)621 470050

Manufacturer (UK):

LINDY Electronics Ltd
Sadler Forster Way
Stockton-on-Tees, TS17 9JY
England
sales@lindy.co.uk, T: +44 (0)1642 754000

Recycling Information



WEEE (Waste of Electrical and Electronic Equipment), Recycling of Electronic Products

Europe, United Kingdom

In 2006 the European Union introduced regulations (WEEE) for the collection and recycling of all waste electrical and electronic equipment. It is no longer allowable to simply throw away electrical and electronic equipment. Instead, these products must enter the recycling process.

Each individual EU member state has implemented the WEEE regulations into national law in slightly different ways. Please follow your national law when you want to dispose of any electrical or electronic products. More details can be obtained from your national WEEE recycling agency.

Battery Remark:

Do not put empty batteries in your domestic waste bin as they will not be recycled. Empty batteries can be returned for recycling at our trade counter or at your local household recycling centre.

The raw materials enclosed in batteries such as Zinc, Iron and Nickel can be reused to a very large proportion. The recycling of batteries and disused/obsolete electronic equipment is one of the most efficient environment protection actions you can easily take.

Germany / Deutschland

Rücknahme Elektroschrott und Batterie-Entsorgung

Die Europäische Union hat mit der WEEE Richtlinie Regelungen für die Verschrottung und das Recycling von Elektro- und Elektronikprodukten geschaffen. Diese wurden im Elektro- und Elektronikgerätegesetz – ElektroG in deutsches Recht umgesetzt. Das Entsorgen von Elektro- und Elektronikgeräten über die Hausmülltonne ist verboten! Diese Geräte müssen den Sammel- und Rückgabesystemen zugeführt werden! Dort werden sie kostenlos entgegen genommen. Die Kosten für den weiteren Recyclingprozess übernehmen die Gerätehersteller.

LINDY bietet deutschen Endverbrauchern ein kostenloses Rücknahmesystem an, beachten Sie bitte, dass Batterien und Akkus den Produkten vor der Rückgabe an das Rücknahmesystem entnommen werden müssen und über die Sammel- und Rückgabesysteme für Batterien separat entsorgt werden müssen. Ausführliche Informationen zu diesen Themen finden Sie stets aktuell auf der LINDY Webseite im Fußbereich.

France

En 2006, l'union Européenne a introduit la nouvelle réglementation (DEEE) pour le recyclage de tout équipement électrique et électronique.

Chaque Etat membre de l' Union Européenne a mis en application la nouvelle réglementation DEEE de manières légèrement différentes. Veuillez suivre le décret d'application correspondant à l'élimination des déchets électriques ou électroniques de votre pays.

Remarque sur les piles et batteries

En tant que consommateur final, vous êtes tenus de restituer toutes les piles et batteries usagées. Il est clairement interdit de les jeter avec les ordures ménagères ! Les piles et batteries contenant des substances nocives sont marquées par le symbole ci-dessus. Vous pouvez déposer gratuitement vos piles ou batteries usagées dans les centres de collecte de votre commune, dans nos succursales ou dans tous les points de vente de piles ou batteries. Vous respecterez ainsi la loi et contribuerez à la protection de l'environnement !

Italy

Nel 2006 l'unione europea ha introdotto regolamentazioni (WEEE) per la raccolta e il riciclo di apparecchi elettrici ed elettronici. Non è più consentito semplicemente gettare queste apparecchiature, devono essere riciclate. Ogni stato membro dell' EU ha tramutato le direttive WEEE in leggi statali in varie misure. Fare riferimento alle leggi del proprio Stato quando si dispone di un apparecchio elettrico o elettronico.

Per ulteriori dettagli fare riferimento alla direttiva WEEE sul riciclaggio del proprio Stato.



Tested to comply with
FCC Standards
For Commercial Use Only!



No. 38263

3rd Edition, January 2021

lindy.com